



www.oskwpc.com



Zhejiang Ousikai New Material Co., Ltd.

📍 No. 1829, Xianghong Road, Jianshan New District, Huangwan,
Haining City, Zhejiang Province, China



Zhejiang Ousikai New Material Co., Ltd.



PRODUCT & DESIGN FOLLOWS NATURE

From simple reproduction of natural designs to redefining ground aesthetics. Ouskye brand new designs of the floor has nearly 100% restored the natural material effect, and integrated into the designer's unique ideas.

Ouskye focus on healthy comfort seekers, value trendy pursuers and balanced home strivers as our target consumers.

Ouskye philosophy of sustainable development covers every aspect of our business: timber resource, research and development, manufacturing, and marketing. All aspects come together to form a complete intelligent quality control system, which strikes the balance between eco-friendliness and quality.

Ouskye philosophy helps provide a healthy and comfortable living space with its outstanding quality, performance, and environment-friendly nature.

Company Profile

Zhejiang Ousikai New Material Co., Ltd has been involved in the manufacturing and exporting LVT/WPC/SPC flooring since 2011. With its technically advanced production equipment, professional technical staffs and experienced sales team, Ouskye produces high value added products at attractive prices to offer unique value to customers worldwide.

Vision - Be the most innovative & valuable flooring company

● **Art** - with rich, authentic reproductions of wood and stone presented in striking, eye-catching patterns and the ability to combine these colors and textures to create imaginative, inspiring spaces.

● **Quality** - by increasing our investment in research and development, we bring the latest in product performance to the flooring market. That enables us to offer some of the best product guarantees in the industry.

● **Nature** - by conserving energy and resources, while reducing our carbon footprint. In this and other ways, Ouskye recognizes the very important responsibility to be environmentally manufacturing standards and sustainable practices to ensure a quality flooring product that is kind to the environment—both indoors and outdoors.



Test Report

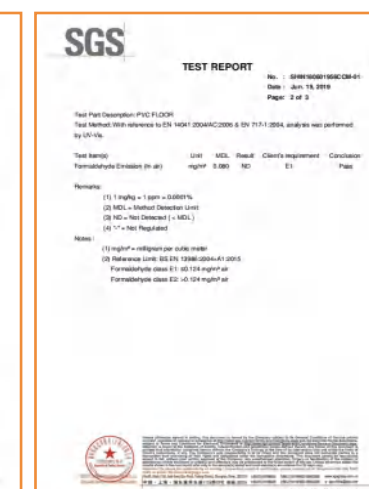
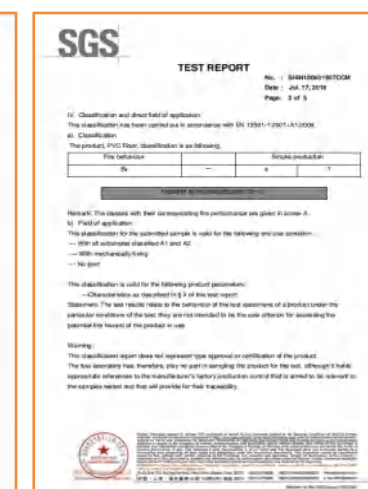
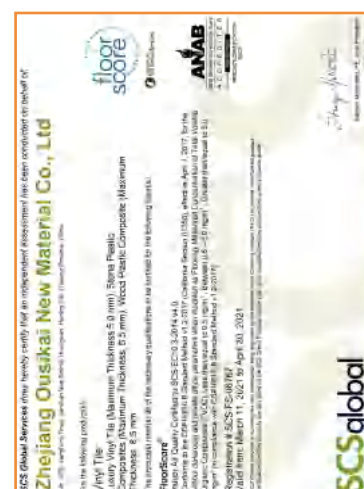

What is WPC?

WPC is a green energy saving and environmental protection product which is extruded from the mixture of recycled wood fiber and plastic (PE).

- Beautiful and elegant nature wood grain texture and touch with easy installation,thus can meet vari-ous requirements of customers.
- Can be shaved, nailed, drilled and cut to fit acces-sories of different specifications.
- No painting,no glue,low maintenance.
- Dimension stability against moisture and tem-perature.
- Environmental friendly,fully recyclableand no other hazard chemical.



Waterproof



Fire Retardant



Fade Resistant



Insect Prevention



Maintenance Free



Anti-corrosion





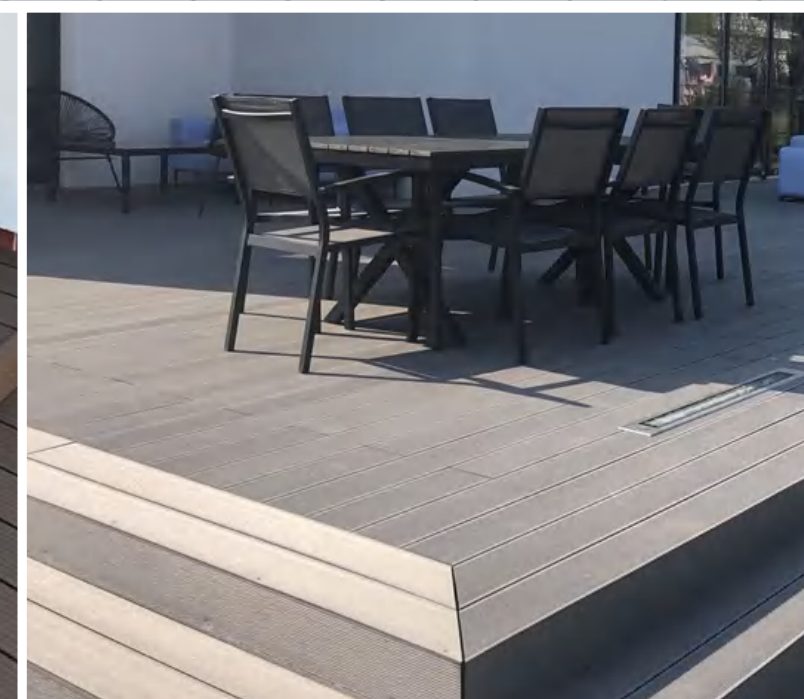
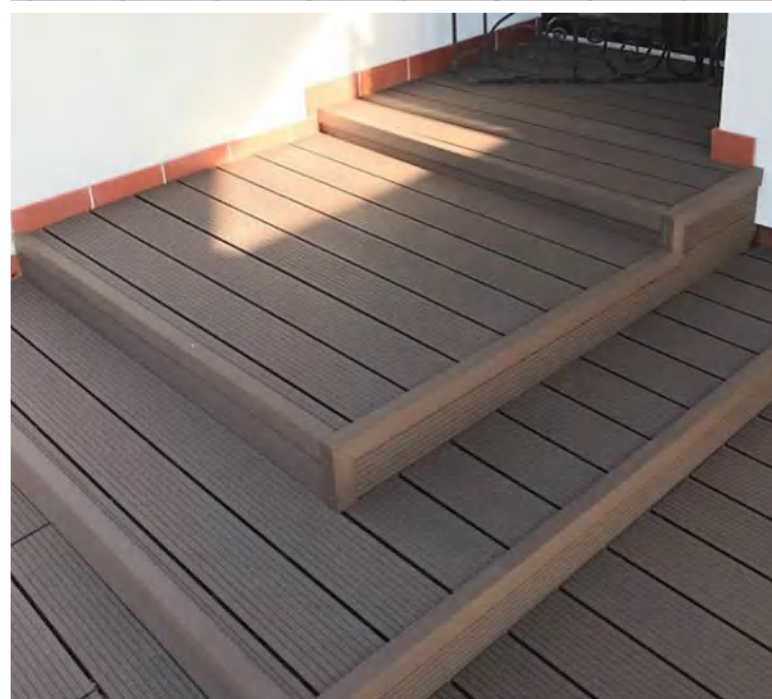





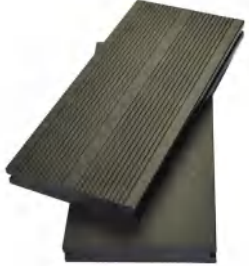

WPC DECKING FLOOR

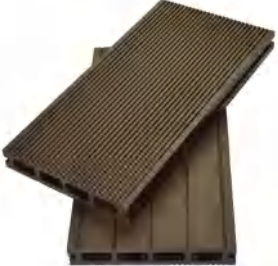
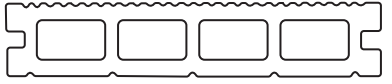

Looking like natural wood,widely used in terrace hotel, swimming pool,port,etc.

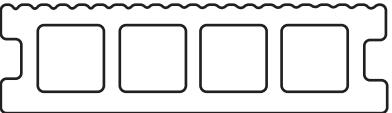



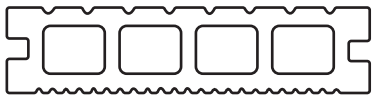

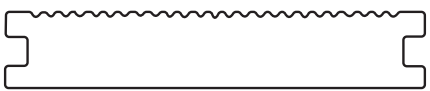

PRODUCT MODEL, PHOTO AND SIZE

A wide range of options for you!

Product model	Picture	Technical drawings	Size
OD-140H-25			140x25
OD-146H-24			146x24
OD-150H-25			150x25
OD-145H-30			145x30
OD-140H-25C			140x25
OD-135H-25A			135x25

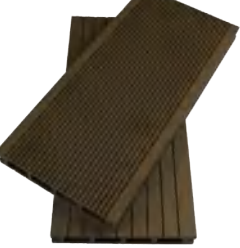
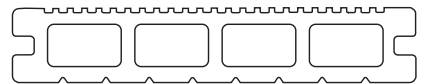
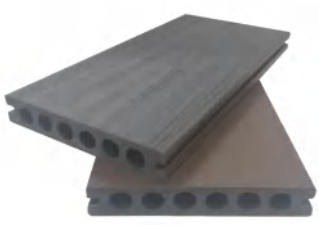
PRODUCT MODEL, PHOTO AND SIZE

A wide range of options for you!

Product model	Picture	Technical drawings	Size
OD-140H-20			140x20
OD-140H-25B			140x25
OD-135H-25			135x25
OD-140H-25H			140x25
OD-150H-25			150x25
OD-150H-23A			150x23

WPC FENCE

Various European fence is beautiful elegant design, maintenance easily insect resistant, high rigidity. It gets you closer to the nature.



Waterproof



Fire Retardant



Fade Resistant



Insect Prevention



Maintenance Free



Anti-corrosion



WPC FENCE

As well as nature wood grain texture and touch thus could meet various requirements of customers



Self made fence is new elegant easily installed design of fence made from WPC panels and Aluminium sections and posts.

WPC Panel
Stze: 210x21mm



Aluminum Poet
Size:68x68x2700mm



Post Cap
Stze:68x68x50mm



Aluminum cover
Stze:20x6mm



Aluminum bottom support
Size:68x68x2700mm



Aluminum U-Groove
Stze:20x12x1836mm



Aluminum Strip
Stze:18x22mm

WPC FENCE

As well as nature wood grain texture and touch thus could meet various requirements of customers

WPC WALL CLADDING

WPC has a wide range of applications. In addition to floors and wallboards, it has a wide range of applications in grapes, handrails, flower boxes, swimming pools and so on.



Waterproof



Fire Retardant



Fade Resistant



Insect Prevention



Maintenance Free



Anti-corrosion

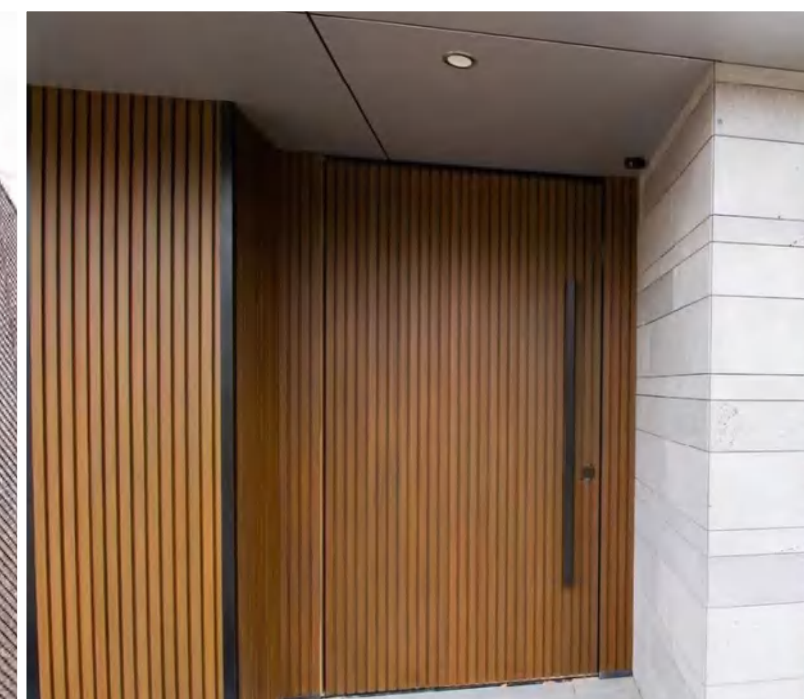







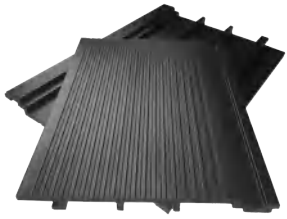

**Wall cladding have favorable mechanical performance.
No need for painting and glue.
But with uv and fade resistance,durable in use.**



PRODUCT MODEL, PHOTO AND SIZE

A wide range of options for you!

Product model	Picture	Technical drawings	Size
OW-212-19			212x19
OW-219-26			219x26
OW-123-23			123x23

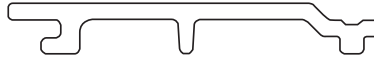
Product model	Picture	Technical drawings	Size
OW-156-21			156x21
OW-225-17			225x17
OW-156-21A			156x21

OTHER WOOD PLASTIC COMPOSITE SERIES





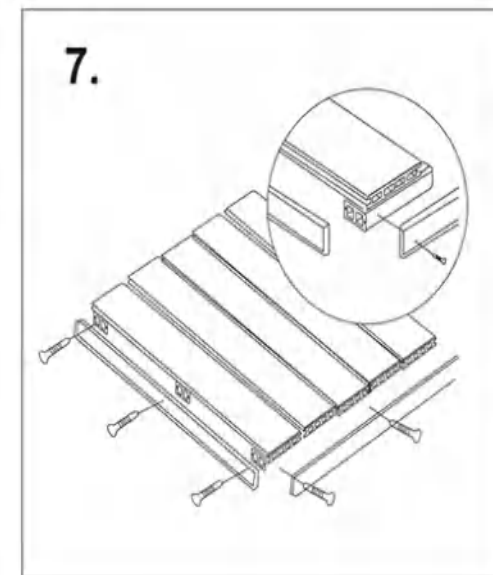
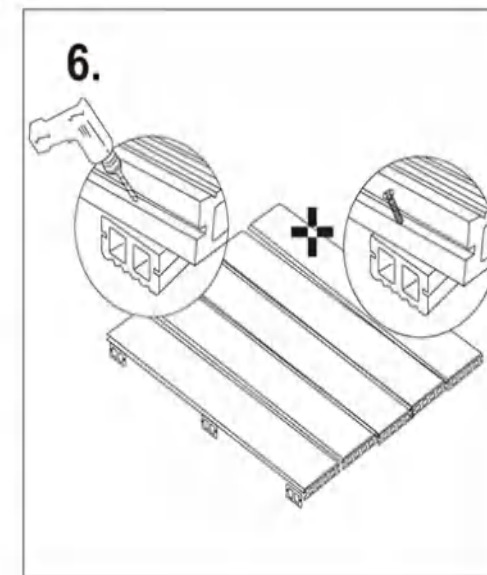
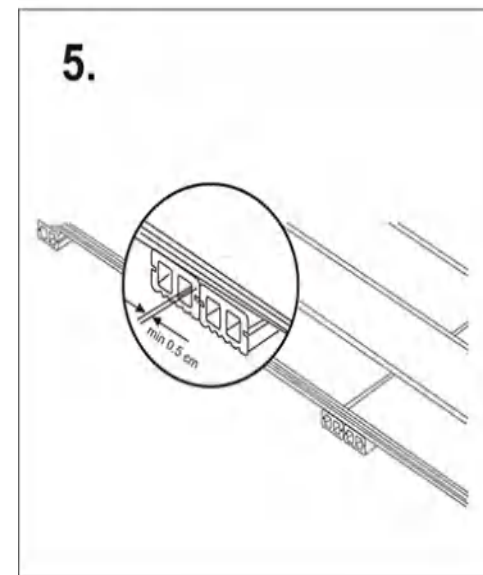
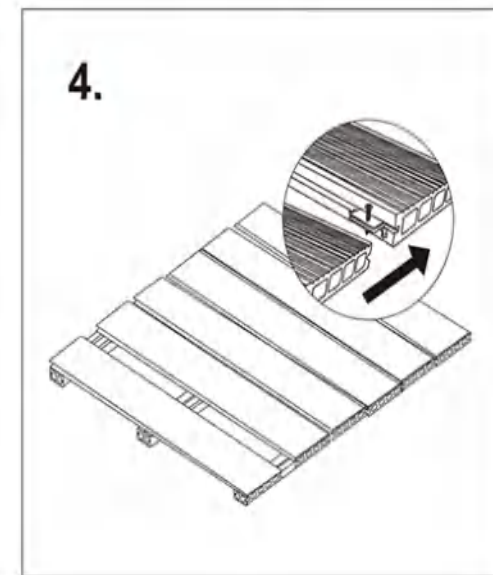
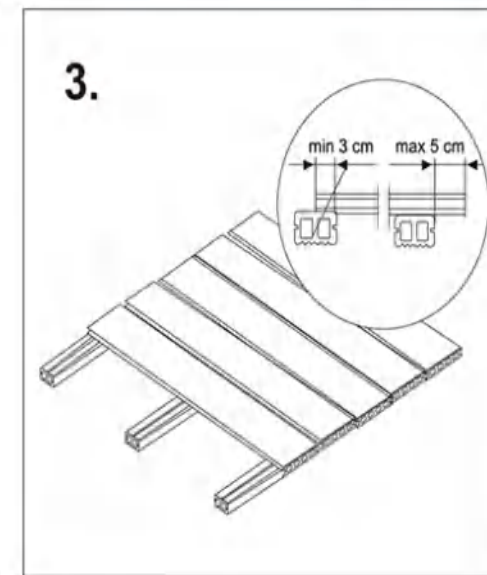
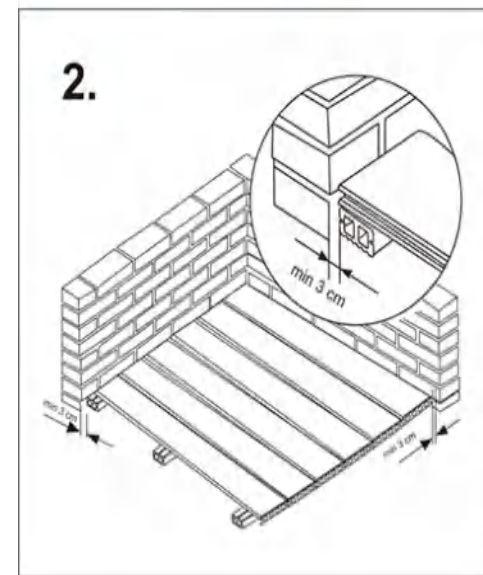
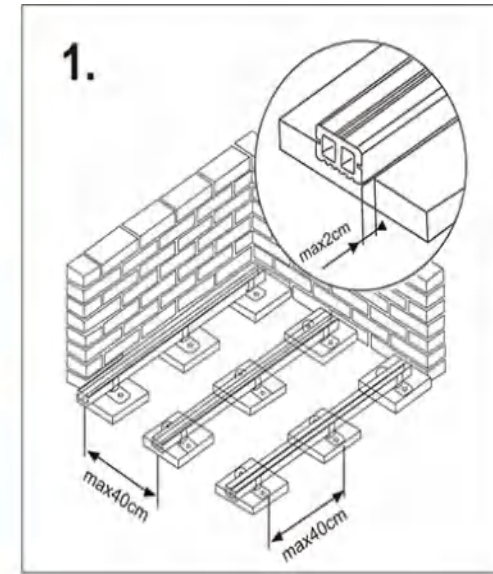

DECKING INSTALLATION



INSTALL ACCESSORIES

Our decking system includes decking boards, rails, connectors and screws, it is easy to install.

- 
Joist
- 
S.S.304 clip
- 
Nylon clip with S.S.screw
- 
Hollow decking endcap
- 
Expansion screw
- 
S.S.304 Start clip

WPC FENCE INSTALLATION

WALL PANEL INSTALLATION

